



artureon

ABSOLUTE DURABLE.
WATERPROOF.

Art by Nature

INSTALLATION INSTRUCTION

Installation Grade Levels, Methods and Environment

This product can be installed on, above or below grade levels, floated, for indoor use only. Please read all the instructions before you begin with the installation. Improper installation will void the warranty.

Important Notice

Every application and installation is different. Therefore, we strongly recommend the customer consult a licensed installer/contractor to verify that the conditions and application meet local requirements or industry expectations. Any installation guidelines are not intended to supersede federal, state, or local regulations which may require modifying the existing installation, materials, or structural components. The owner/installer assumes responsibility for compliance with all building codes, including maintaining the required distance from heat sources such as fireplaces.

SAFETY CAUTION: USE SAFETY GLASSES AND GLOVES WHEN CUTTING THIS PRODUCT. DURING THE CUTTING PROCESS, THIS PRODUCT MAY CREATE WOOD DUST; BE SURE TO INSTALL IN A WELL-VENTILATED AREA.

Owner/Installer Responsibility

The owner/installer should inspect the flooring for defects prior to installation and during installation. During installation, do not install boards which appear to be defective. The owner/installer should check the decor and appearance with the customer. Installed floor can not be returned. The owner/installer is responsible for the job site being structurally acceptable (see local building codes) for installation. The owner/installer is responsible for flooring failures resulting from or related to subfloor, subsurface, job site damage or deficiencies after the flooring has been installed.

Job Site Condition

Manufacturer will decline responsibility for situations associated with improper installation or poor site conditions. Pouring of basement concrete floors, drywall and plasterwork, plumbing, etc. must be completed well in advance of the floor installation. Job site should be in a normal living condition, i.e., room temperature of more than 18°C (64°F) and relative humidity (RH) level of less than 70%.

Concrete Subfloor Requirements

Concrete subfloor must be cured, clean and must be flat and leveled (3 mm for every 1 m (3/16 inch for every 10 feet)). The moisture content must be less than 2.5% for cement-bound screed (CM method) and 0.5% for an anhydrite bound screed. Always use an underlay. Contact your sales representative for suitable underlay options. Minimum specification of the moisture barrier is 0,2 mm virgin polyethylene sheet.

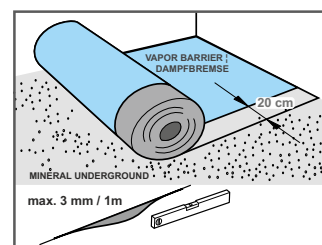
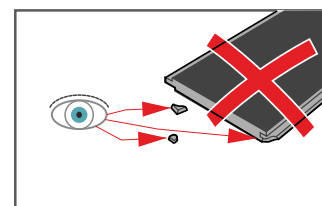

Wood Subfloor Requirements

Wood subfloor must be clean, must be flat and leveled (3mm for every 1 meter (3/16 inch for every 10 feet)). Wood subfloor must have a moisture content of less than 14%. Wood subfloor must be structurally sound.

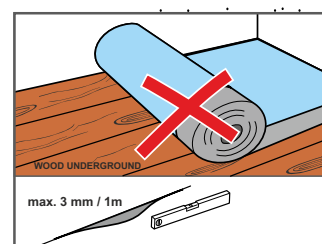

Existing Floor Coverings

Existing floor coverings must be adhered to the subfloor (acceptable floor coverings: wood, vinyl and linoleum). Existing floor coverings must be clean and must be flat and leveled (3 mm for every 1 meter (3/16 inch for every 10 feet)). An installation over a carpet floor is not permitted.

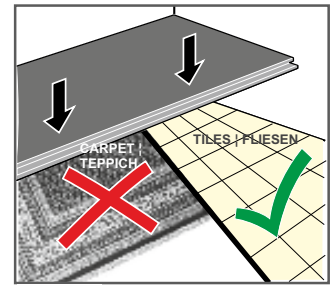

Radiant Heated Floor

The product can be installed over embedded liquid heating systems. Lower heating system to 18°C (64°F) for 1 week before installation. After installation slowly increase the temperature in increments of 5°C (9°F) per 24 hours. The finished floor surface temperature must not exceed 27°C (81°F) throughout the service life of the floor. Follow installation requirements for concrete as outlined above. An ideal climate during the heating period is a temperature of 20 - 22°C (68 – 72°F) and a relative humidity of 50 - 60%.

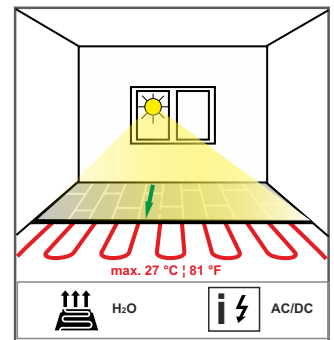

Acclimation

Before the installation, an acclimation of the floor is needed. The unopened packages need to be stored for at least 24 hours at room temperature (at least 18°C) where it will be installed is needed.

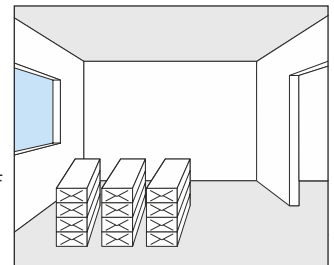

Expansion Gaps

Leave an expansion gap of 10 mm (3/8 inch) around the floor and vertical structures such as pipes, stairs and kitchen Islands to allow for movement of the floor. Also include expansion joint between rooms.

Tools and material needed

You may need the following tools to install this product:

- tape measure, square edge, pencil, rubber mallet,
- circular saw, jigsaw, hand saw, or cross-cut saw
- spacers
- safety equipment (safety glasses, mask (during sawing) and work gloves.)
- PE foil, insulation, Stanley knife or box cutter, possibly sticky tape
- floor, skirting boards, transition profiles, underlay

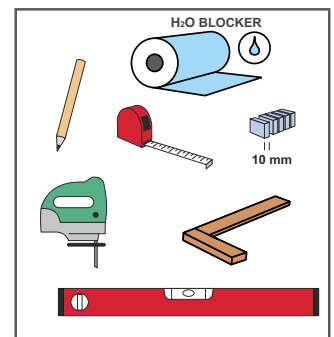

Helpful Considerations

Work in a well-lit area. Remove all existing moldings. Install flooring perpendicular to the direction of the floor joists. If possible, install the boards parallel to the direction of the light entering the room. Tape all seams. Check door clearances, making necessary adjustments before laying the floor. It is also very helpful to calculate the panel lengths for the first two or three rows and cut them to size. The panels of the last row shouldn't be less than 40 mm.

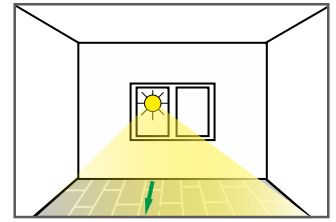

Cooking islands for kitchens and other very heavy objects should be installed first and not placed on top of the floor. The floor must be able to move around the heavy objects to avoid open joints and separating planks.

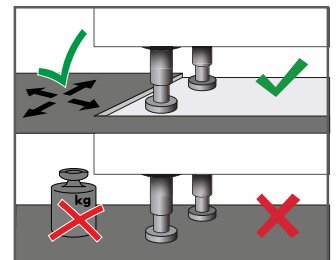

The floor is intended to float on the subfloor. In other words, it should not be glued, nailed, otherwise fastened or heavy objects placed on it. As wood is a natural material, the floor works and moves. The floating installation and expansion gap of minimum of 10mm at perimeter and at other vertical obstacles ensure enough leeway for it to flex and expand slightly.

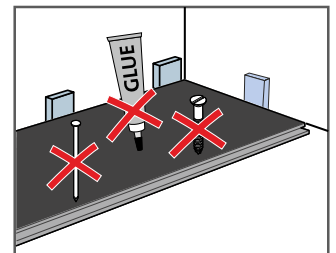

Mix boxes

Installation shall be done by mixing several boxes from same batch to avoid colour differences and set repetitions.

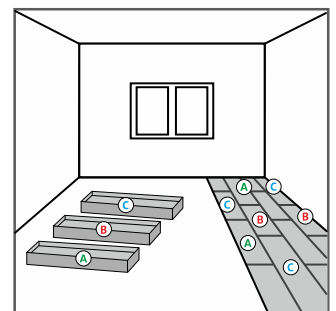

Entrance (cleaning) mats

Every type of floor covering must be protected from coarse dirt and water/snow through suitable clean-off zones. For this reason, entrance areas must be fitted with a properly sized clean-off zone / doormat. In commercial applications, where the flooring surface leads directly from outside, an appropriately sized clean-off zone of around 3-4 steps, should be used.

Step-by-Step Instructions:

After making sure that the subfloor is suitable and the floor panels were acclimated for at least 24 hours, you can proceed with the installation:

- 1.** First install the underlay. Lay underlay sheets at 90° angles to the direction that the flooring panels will run. The specially designed ProVent underlay has a damp-proof, insulating, noise-reducing and leveling function. If not using ProVent underlay, you need a PE-sheet as a moisture barrier, especially when laying flooring on new subfloors. It prevents moisture damage to the upper and lower sections of the floor. Either overlap the sheets by 20 cm or glue them edge to edge. Make sure that they extend up the walls by about 3 cm.
- 2.** Lay the first row of the flooring panels. Start in the right-hand corner of the room and lay the panels so they run parallel to the window or other light source. Lay the panels lengthwise along the wall leaving a 10 mm wide gap and click their short sides together. Wood wedges are excellent spacers. You will almost certainly have to shorten the last panel in the row. The last piece shouldn't be shorter than 40 cm. In order to prevent such a case, the first panel may also need to be shortened (making sure that it is also at least 40 cm long).
- 3.** For the cutting of the panels, make sure they facing the decor side down. Make therefore you marks on the back.
- 4.** You can start the next row with the piece left over from cutting the first, provided that it is at least 40 cm long. This will result in an attractive stepped pattern. The tongue-and-groove joints in adjacent rows should be staggered by at least 40 cm to stabilise them. Insert each new panel at a sharp angle into the edge of the already-laid panel and press it down until you hear it audibly click into place. It is easily done by lifting both panels a bit at the shared joint and then pushing down on it until it clicks. The angle is right if you can easily connect the panels without exerting any force. You will get the hang of it fast and don't need a hammer for the connection!

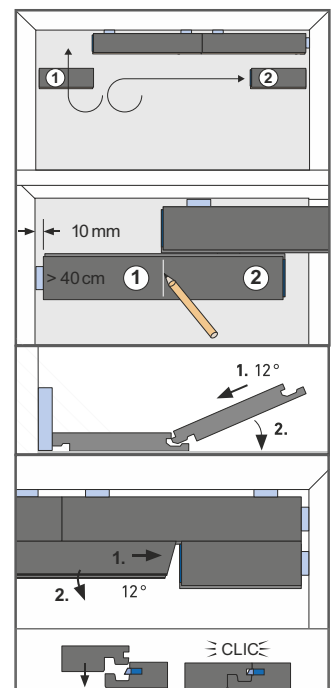
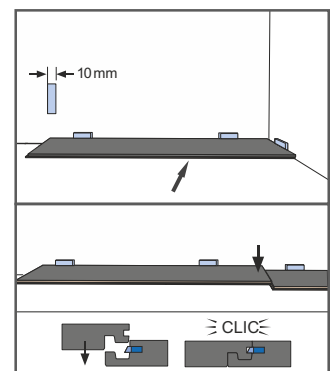
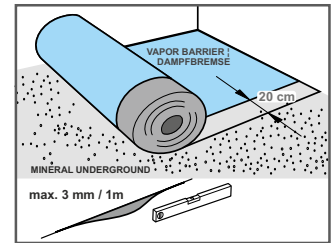

5. The last row of flooring will almost certainly be too long, making it necessary to trim it. Remember to leave a sufficient gap along the wall. If the panels there are also too wide, they must be made narrower. Remove the 5G plastic tongue before cutting planks for the first and last row. Cut the 5G plastic tongue to size and reinsert. Remove the blue springs if the panel has too less width. Than join the panels using a D3 glue.

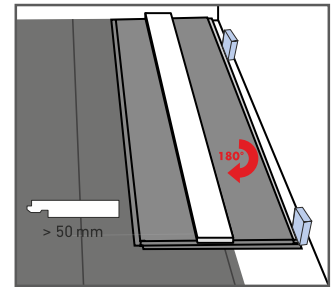

6. Remove all spacers.

7. Complete your flooring installation with the skirting of your choice to cover the expansion gaps. Ensure that the skirting is attached to the wall and does not fix the floor panels to the ground. Transition rails must be mounted between different floor coverings in adjacent rooms. Depending on the type of rails, they have to be glued, screwed or snapped into place.

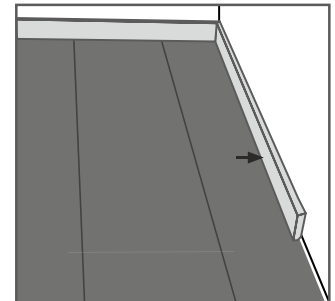

Expansion joint profiles for doorways and for large rooms

Expansion joint profiles are required at doorways, archways (door-less openings between room), protruding masonry and rooms with complex shapes. With lengths of more than 20 m and widths of more than 20 m, there should be an intermediate expansion gap. The swelling and shrinking is linear, so the bigger the surface, the bigger the leeway at the edge has to be.

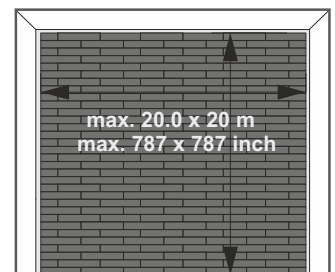

REMOVAL: Planks must be disengaged from any proceeding or subsequent rows before attempting to remove the panels from each other. Slide planks than on the same plane as the sub floor.

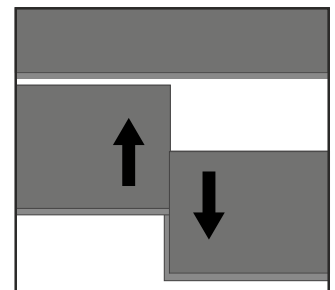

Special Installation Situations:

Heating Pipes

Where heating pipes stick out of the floor, first cut the panel to the right length, then lay it next to where it will go and use a folding rule to measure and mark where the openings are needed. Here too, remember to leave a 10 mm gap around them. Now you can use a drill to remove the marked areas. Apply D3 glue to the sawed-off piece, place it behind the heating pipe and tightly join it to the other piece of panel.

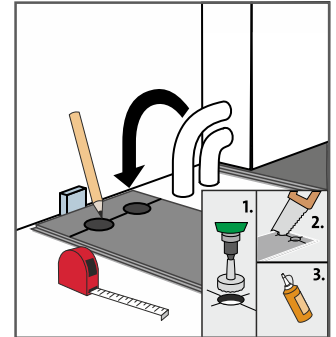

Door Frames

Check that the doors can still open and close after the floor and underlay have been installed. If the doorframe is installed after the floor installation, please make sure that a min. 1 mm vertical gap is left between the base of the door-frame and the surface of the floor.

Wooden doorframes should be shortened. Lay a panel next to the frame with the decor side down. Use a suitable saw to sufficiently shorten the frame, then slide the panel underneath it with the decor side up. With steel doorframes that can't be shortened, make an appropriately shaped cut-out in the panel instead.

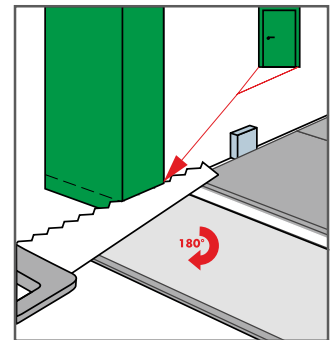

Finishing in wet rooms as bathrooms

These installation instructions can prevent water infiltration around the perimeter and obstacles of your floor in wet areas. The water-resistant floor is not suitable for use in damp spaces like showers, pool areas, saunas and rooms with build-in drains.

Please note that some national regulations are not allowing floating installation in wet rooms. National regulations regarding floor applications must always be followed.

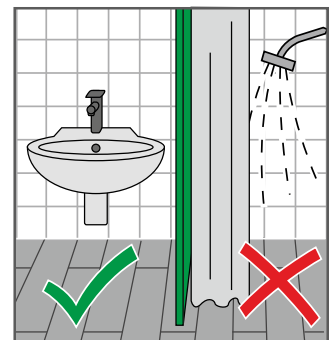

Sealing the perimeter expansion gaps combines a compressible PE foam with diameter 8 to 10 mm and the flexible and elastic sealant. Push the PE foam in the expansion gaps and apply the elastic sealant under slight angle towards the floor.

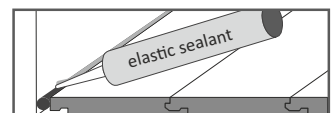

For a perfect water resistant finishing around pipes, use pipe covers, the elastic sealant and the PE-foamstrip. Put the foamstrip in the expansion gap around the pipe and apply elastic sealant on top of the flexible PE foam that is in the expansion gap. Then place the pipe cover and apply elastic sealant around the pipe cover and around the tubes. This makes the ingress of water impossible.

End of life – Waste treatment

Packaging

The transport packaging paper, cardboard and film can be collected separately and recycled appropriately. Retrieval of the packaging material can be arranged with the manufacturer in individual cases.

Reuse

In case of careful deconstruction and proper storage, reuse is possible for the same application. In case of a desired reuse, may the panels not be tied over their entire back side or along the profiles. Special care must be taken when disassembling the floor to keep the profiles intact.

Recycling

After its utilization phase, the product should be separated and routed to an energetic recovery, due to its high calorific value of approx. 17 MJ/kg. Upon incineration, kindly observe all locally applicable legal requirements for the correct dimensions, required filter technologies, operating conditions, and legal permissions for burning wood-based panels.

